

OBSOLETE PRODUCT
NO RECOMMENDED REPLACEMENT
contact our Technical Support Center at
1-888-INTERSIL or www.intersil.com/tsc

100V Half Bridge Driver

élantec

The EL7761 provides a low cost solution to many half bridge applications. The EL7761 is DC

coupled so that there are no start up problems associated with AC coupled schemes. A single resistor from D_{SET} to GND provides "dead time" programmability. Shorting D_{SET} to V_{DD} gives the shortest delay (~100ns).

The POL pin controls the polarity of the low side driver. The polarity of the upper driver is always inverting. The EN pin, when low, forces the high and low side outputs into their low state.

Pinout

EL7761
(16-PIN PDIP, SOIC)
TOP VIEW

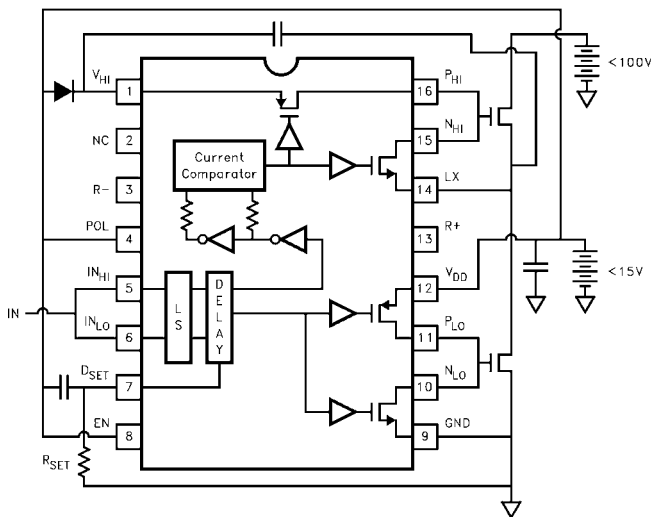

EL7761 WAVEFORM EXAMPLE

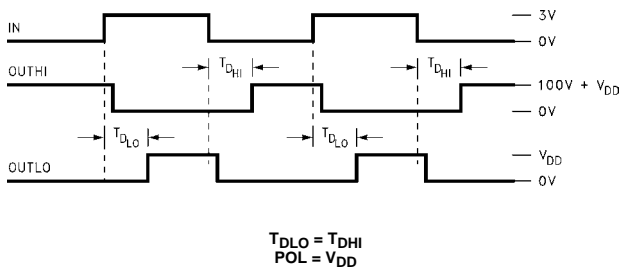

Features

- 100V High Side Voltage
- Programmable Delay
- Direct Coupled
- No Start Up Ambiguity
- Rail to Rail Output
- 1MHz Operation
- Shutdown Function
- 1.0 Amp Peak Current
- Improved Response Times
- Matched Rise and Fall Times
- Low Supply Current
- Low Output Impedance
- Low Input Capacitance

Applications

- Uninterruptible Power Supplies
- Distributed Power Systems
- IGBT Drive
- DC-DC Converters
- Motor Control
- Power MOSFET Drive
- Switch Mode Power Supplies

Ordering Information

PART NUMBER	TEMP. RANGE	PACKAGE	PKG. NO.
EL7761CN	-40°C to +85°C	16-Pin PDIP	MDP0031
EL7761CS	-40°C to +85°C	16-Pin SOIC	MDP0027(Note)

NOTE: Contact factory

	POL	POLARITY
Low Side	GND V _{DD}	Inverting Non-Inverting
Hi Side	X	Inverting

EL7761

Absolute Maximum Ratings (T_A = 25°C)

Supply (V _{HI} to GND) 100V	Storage Temperature Range -65°C to +150°C
Supply (V _{DD} to GND) 16.5V	Ambient Operating Temperature -40°C to +85°C
Input Pins -0.3V below GND, +0.3V above V _{DD}	Operating Junction Temperature 125°C
Peak Current per Output 2A	Power Dissipation
	SOIC 1100mW
	PDIP 1800mW

CAUTION: Stresses above those listed in "Absolute Maximum Ratings" may cause permanent damage to the device. This is a stress only rating and operation of the device at these or any other conditions above those indicated in the operational sections of this specification is not implied.

IMPORTANT NOTE: All parameters having Min/Max specifications are guaranteed. Typical values are for information purposes only. Unless otherwise noted, all tests are at the specified temperature and are pulsed tests, therefore: T_J = T_C = T_A

DC Electrical Specifications T_A = 25°C, V_{DD} = 15V, C_{LOAD} = 1000pF, unless otherwise specified

PARAMETER	DESCRIPTION	TEST CONDITIONS	MIN	TYP	MAX	UNITS
INPUT/OUTPUT						
V _{IH}	Logic "1" Input Voltage		3.0	2.4		V
I _{IH}	Logic "1" Input Current			0.1	10.0	μA
V _{IL}	Logic "0" Input Voltage			1.8	0.8	V
I _{IL}	Logic "0" Input Current			0.1	10.0	μA
V _{HVS}	Input Hysteresis			0.5		V
V _{ENH}	Enable Threshold	Positive Edge	2.8	1.6		V
V _{ENL}	Disable Threshold	Negative Edge		0.9	0.6	V
V _{EN HYS}	Enable Hysteresis			0.7		V
I _{DS OFF}	Output Leakage	GND ≤ V _{OUT} ≤ V _{DD}	-10.0	0.2	10.0	μA
R _{OH}	Pull-up Resistance	I _{OUT} = -100mA		5.0	10.0	Ω
R _{OL}	Pull-down Resistance	I _{OUT} = +100mA		5.0	10.0	Ω
I _{PK}	Peak Output Current			1.0		A
I _{DC}	Continuous Output Current Source/Sink		50.0			mA
POWER SUPPLY						
I _{DD}	Supply Current into V _{DD}	R _{SET} = 5.1k		6.0	10.0	mA
I _{HI}	Supply Current into V _{HI}			2.0	4.0	mA
I _{DD OFF}	Supply Current into V _{DD}	V _{EN} = 0.6V			750.0	μA
V _{DD}	Operating Voltage		4.5		15.0	V

EL7761

AC Electrical Specifications $T_A = 25^\circ\text{C}$, $V_{DD} = 15\text{V}$, $C_{LOAD} = 1000\text{pF}$, unless otherwise specified

PARAMETER	DESCRIPTION	TEST CONDITIONS	MIN	TYP	MAX	UNITS
SWITCHING CHARACTERISTICS						
t_R	Rise Time	$C_L = 500\text{pF}$ $C_L = 1000\text{pF}$		15.0 20.0	40.0	ns
t_F	Fall Time	$C_L = 500\text{pF}$ $C_L = 1000\text{pF}$		15.0 20.0	40.0	ns
$t_{D\ ON\ HI}$	High Side Turn On Delay Time	$D_{SET} = V_{DD}$ $R_{SET} = 5.1\text{k}$ $R_{SET} = 400\text{k}$	50.0 75.0 750.0	100.0 125.0 1150.0	150.0 200.0 1500.0	ns
$t_{D\ ON\ LO}$	Low Side Turn On Delay Time	$D_{SET} = V_{DD}$ $R_{SET} = 5.1\text{k}$ $R_{SET} = 400\text{k}$	50.0 75.0 750.0	100.0 125.0 1150.0	150.0 200.0 1500.0	ns
$t_{D\ OFF\ HI}$	High Side Turn Off Delay Time	$D_{SET} = V_{DD}$		100.0	150.0	ns
$t_{D\ OFF\ LO}$	Low Side Turn Off Delay Time	$D_{SET} = V_{DD}$		100.0	150.0	ns
$t_{D\ MISMATCH}$	High to Lo Side Turn On Delay Mismatch	$R_{SET} = 400\text{k}$			± 10.0	%

Pin Descriptions

PIN #	NAME	FUNCTION
1	V_{HI}	Positive supply for the high side driver.
2	NC	
3	R^-	Internal connection between the low side and high side driver. This pin is normally unconnected.
4	P_{OL}	Controls the polarity of the low side driver.
5	IN_{HI}	Logic input for the high side driver.
6	IN_{LO}	Logic input for the low side driver.
7	D_{SET}	Connection for the delay adjust resistor.
8	EN	A high voltage on this pin enables the part.
9	GND	Negative supply of the low side driver and control circuitry.
10	N_{LO}	Low side driver output pull down.
11	P_{LO}	Low side driver output pull up.
12	V_{DD}	Positive supply of the low side driver and control circuitry.
13	R^+	Internal connection between the low side and high side driver. This pin is normally unconnected.
14	LX	Negative supply for the high side driver.
15	N_{HI}	High side driver output pull down.
16	P_{HI}	High side driver output pull up.

Typical Performance Curves

Quiescent Supply Current vs. Supply Voltage

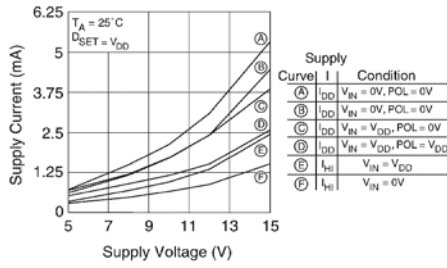

Avg. Supply Current into V_{DD} vs. Voltage and Frequency

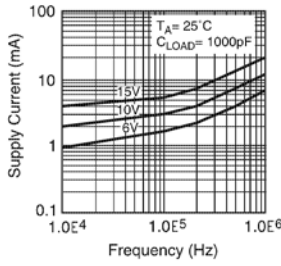

Average Supply Current into V_{HI} vs. Voltage and Frequency

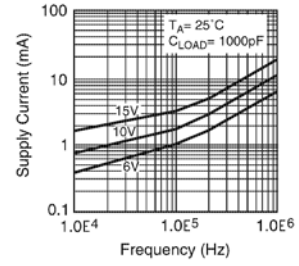

Output Rising Edge Delay vs. R_{SET} and Supply Voltage

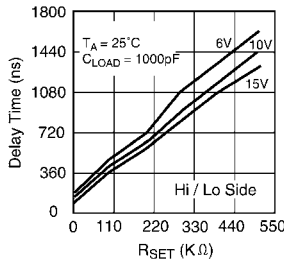

Output Rising Edge Delay vs. R_{SET} and Supply Voltage (Detail)

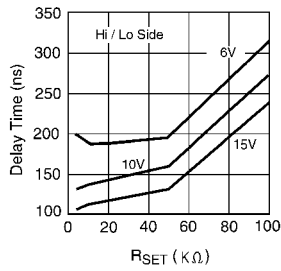

Output Rising Edge Delay vs. Temperature and R_{SET}

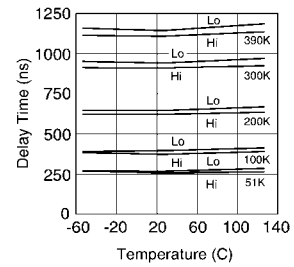

Output Falling Edge Delay vs. Supply Voltage and Temperature

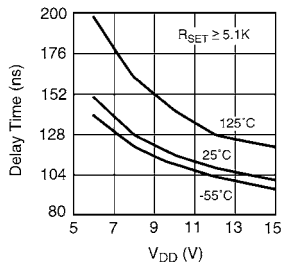

Delay Times* vs. Supply Voltage and Temperature

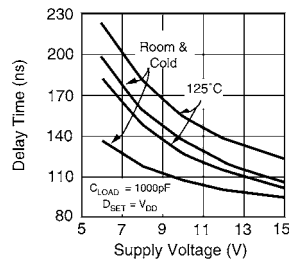

*Minimum Rising and Falling Edge Delay Time

Typical Performance Curves

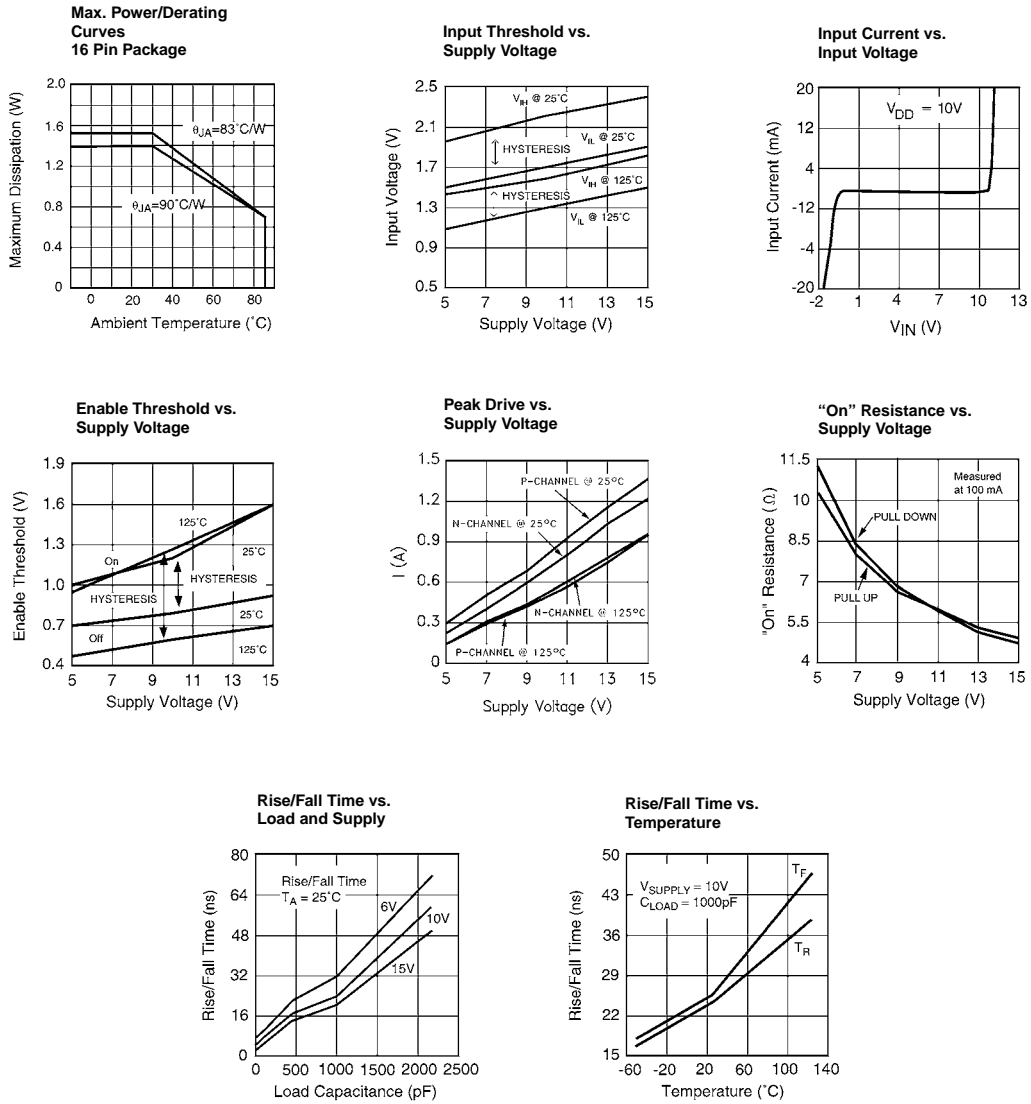

All Intersil U.S. products are manufactured, assembled and tested utilizing ISO9000 quality systems. Intersil Corporation's quality certifications can be viewed at www.intersil.com/design/quality

Intersil products are sold by description only. Intersil Corporation reserves the right to make changes in circuit design, software and/or specifications at any time without notice. Accordingly, the reader is cautioned to verify that data sheets are current before placing orders. Information furnished by Intersil is believed to be accurate and reliable. However, no responsibility is assumed by Intersil or its subsidiaries for its use; nor for any infringements of patents or other rights of third parties which may result from its use. No license is granted by implication or otherwise under any patent or patent rights of Intersil or its subsidiaries.

For information regarding Intersil Corporation and its products, see www.intersil.com